

Data Sheet



Article number: 021816011350

Description: Clamp with bracket and rubber
SPGU 6011. 350/30 SK

Measures

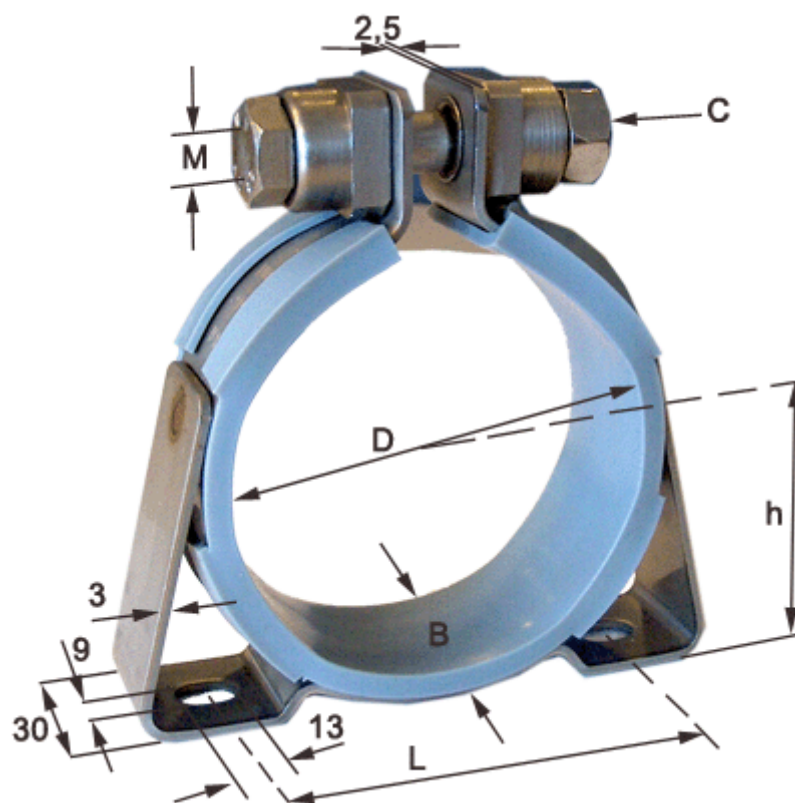

C (screw type) = SK hexagon screw

Diameter D = 350

h = 184

L = 345

Width B = 30